



MOULDING PROFILES

www.nordecor.com

888-565-4730

218-824-7272

218-824-7274 (fax)

**Nordecor
924 Thiesse Dr.
Brainerd, MN 56401**

CONTENTS

<u>Section</u>	<u>Page</u>
Casing	1
Head Casing	2
Apron Casing	2
Backband	3
Bead	3
Stool	3
Base	4,5
Shoe	5
Cove	6
Crown	7
Rail	8,9
720 Series	10
Loon Country	11

CASING



LC02-275
5/8 x 2 3/4

LC02-325
5/8 x 3 1/4



N374
3/4 x 3 1/4

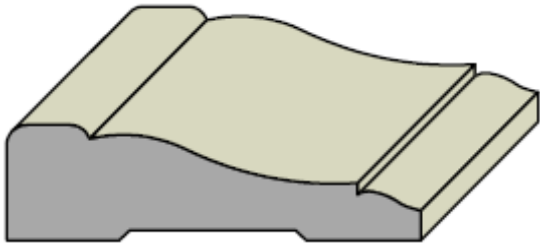

N392
11/16 x 2 1/2

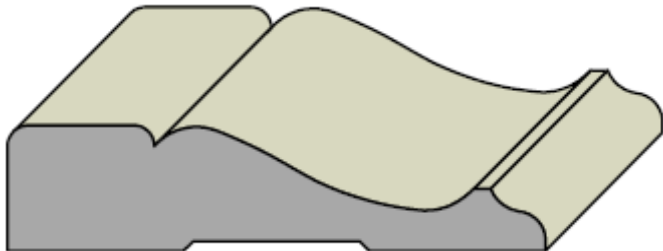

N401
3/4 x 3 1/4

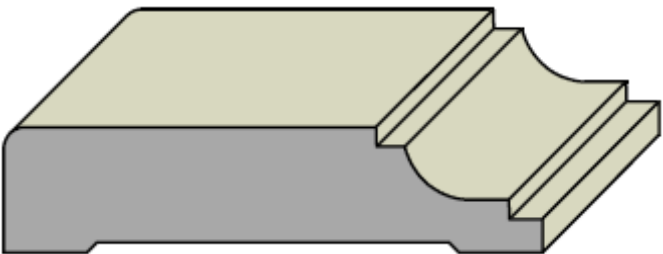

N993C
3/4 x 3 1/4

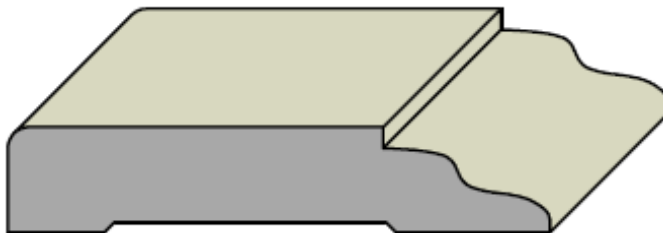

N722C
5/8 x 3 1/4

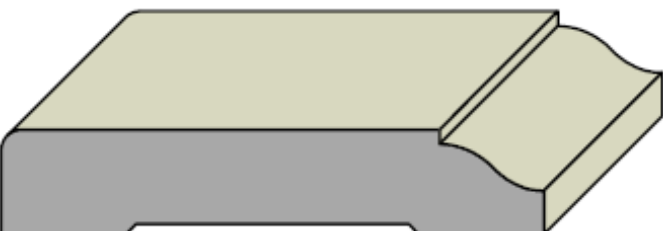

N136C
11/16 x 3 1/4

HEAD & APRON CASING



LC01-525-1 (1 EE)
LC01-525-2 (2 EE)
3/4 x 5 1/4



LC01-425-1 (1 EE)
LC01-425-2 (2 EE)
3/4 x 4 1/4



LC01-325-1 (1 EE)
LC01-325-2 (2 EE)
3/4 x 3 1/4

BACKBAND

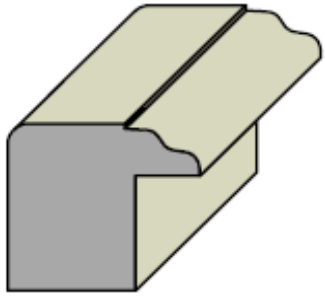

N725
1 x 1 1/4 x 5/8

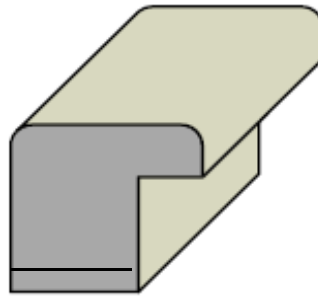

LC9125-1
1 x 1 1/4 x 3/4

LC9125-2
7/8 x 1 1/4 x 5/8

BEAD & STOOL

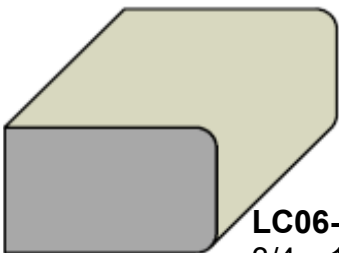

LC06-125
3/4 x 1 1/4

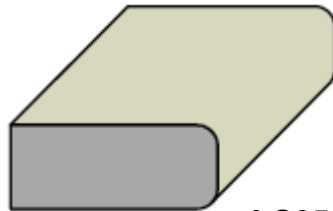

LC05-125
1/2 x 1 1/4

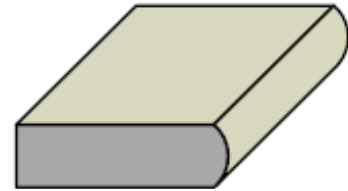

N599
3/8 x 1 1/4

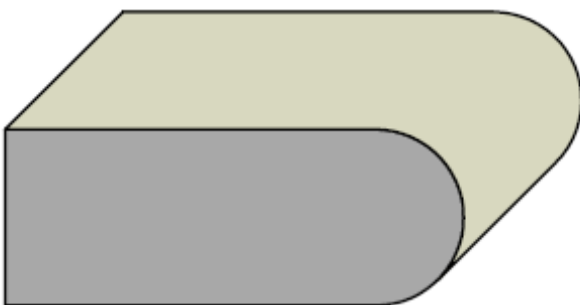

N623
1 1/16 x 2 1/2

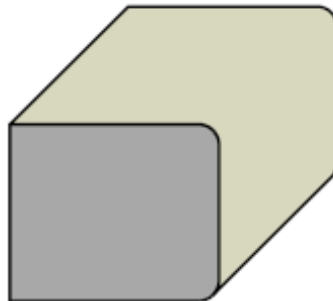

N730
1 1/16 x 1 1/4

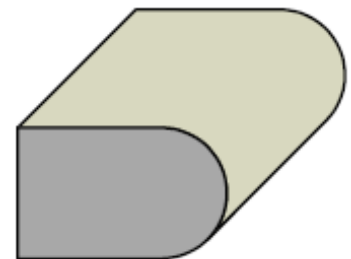

N485
3/4 x 1 1/4

BASE



N136B *
9/16 x 5 1/4

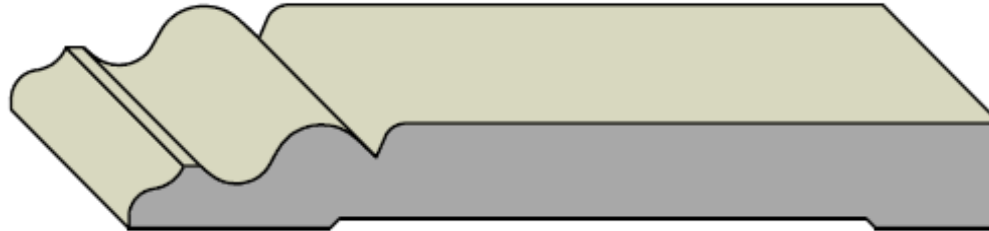

N496 *
5/8 x 5 1/4



N618 *
5/8 x 5 1/4



N993B *
3/4 x 5 1/4



N722B *
1/2 x 5 1/4



N728
3/4 x 7 1/4



N982
5/8 x 7 1/4

* Also available in 3 1/4 and 4 1/4 widths

BASE



LC03-525
1/2 x 5 1/4



LC03-425
1/2 x 4 1/4

SHOE

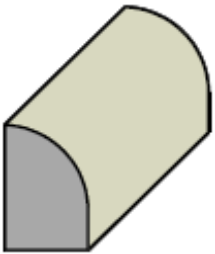

N130
1/2 x 3/4

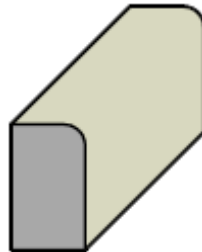

LC04-075
7/16 x 3/4

COVE

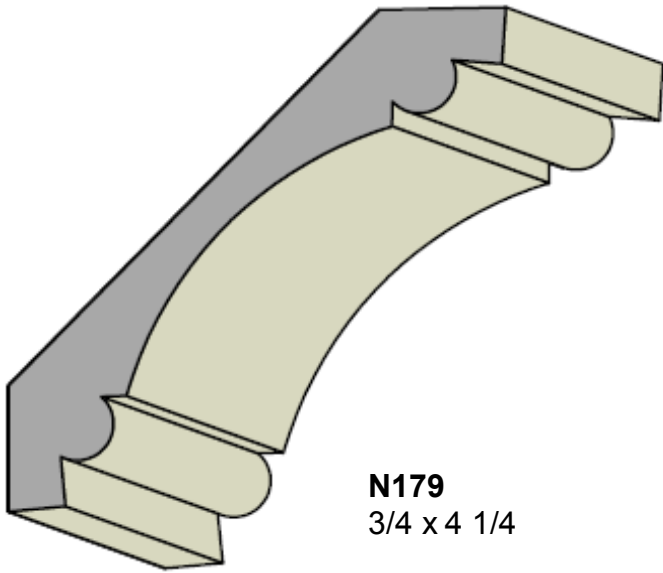

N179
3/4 x 4 1/4

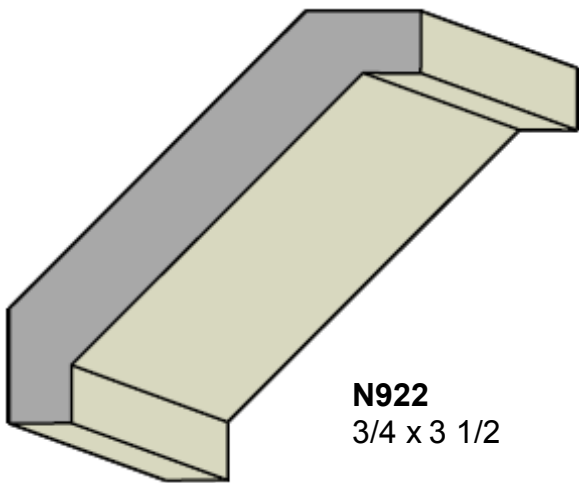

N922
3/4 x 3 1/2

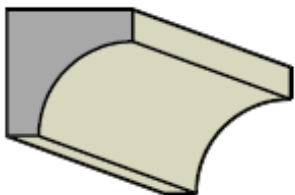

N854
3/4 x 3/4

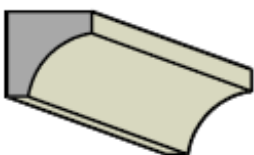

N853
1/2 x 1/2

CROWN

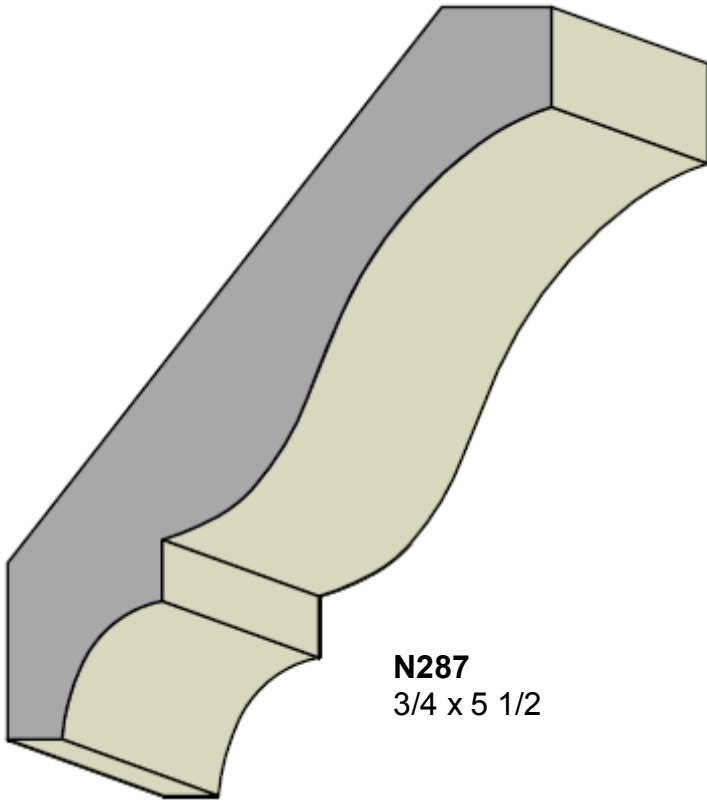

N287
3/4 x 5 1/2

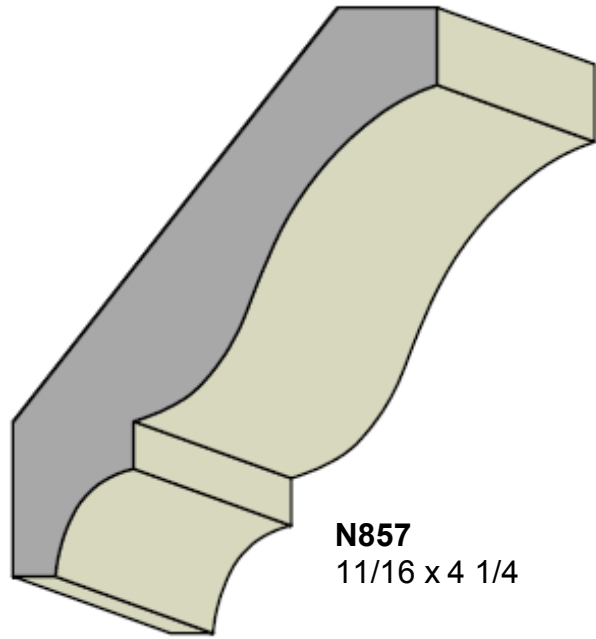

N857
11/16 x 4 1/4

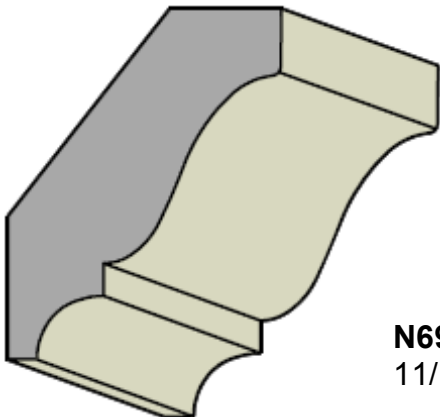

N691
11/16 x 2 3/4

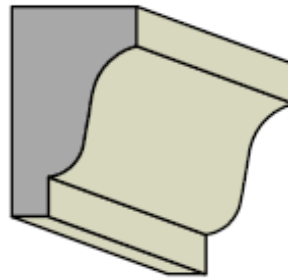

N600
3/4 x 1 1/4

RAIL

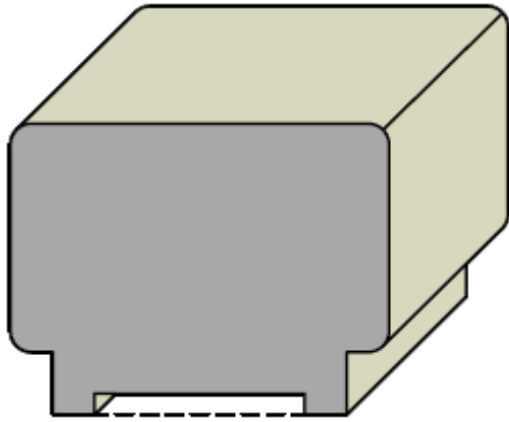

N717P (with 1 1/4 plow)
N717 (no plow)
1 3/4 x 2 1/4

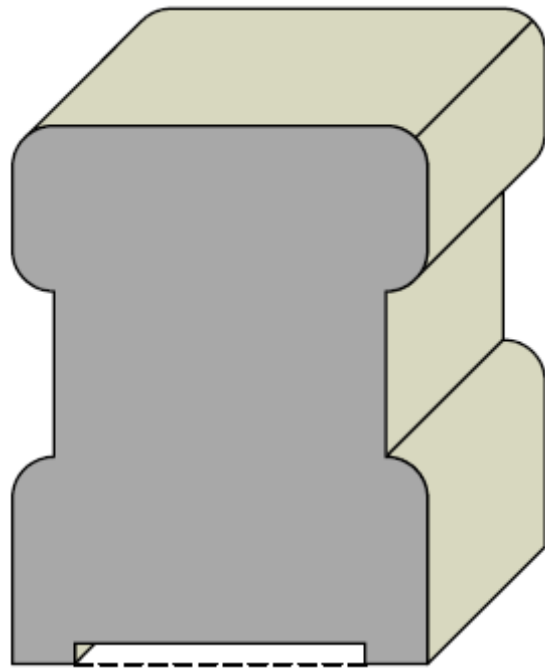

N603P (with 1 3/4 plow)
N603 (no plow)
3 1/2 x 2 3/4

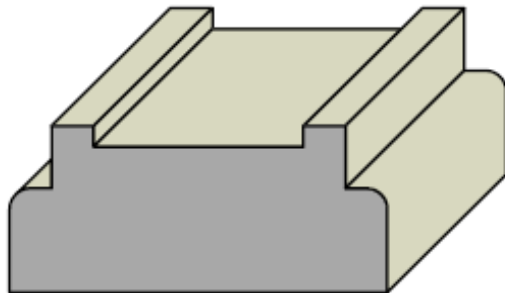

N717S (1 1/4 Plow)
1 x 2 1/4

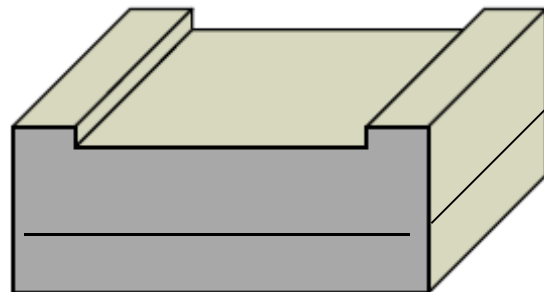

N603B (1 3/4 Plow)
1 1/4 x 2 3/4
N603S (1 3/4 Plow)
3/4 x 2 3/4

RAIL

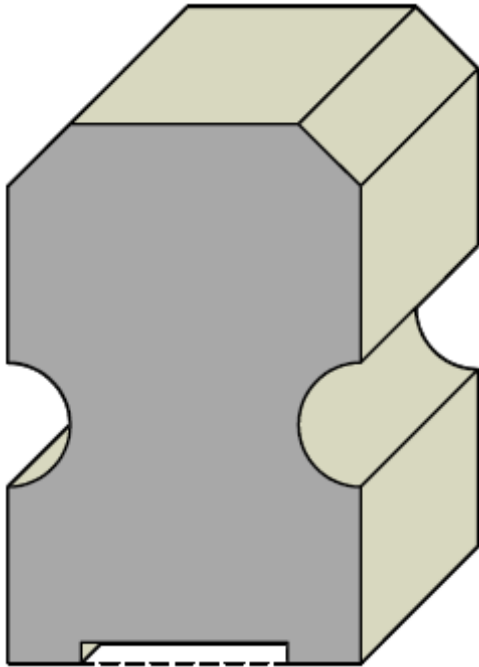

N379P (with 1 1/4 plow)

N379 (no plow)

3 1/4 x 2 1/8

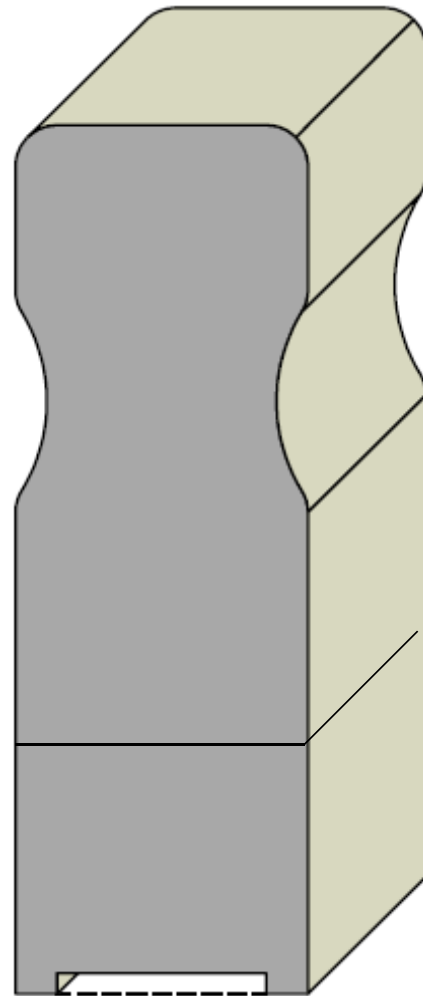

N720-4P (with 1 1/4 plow)

N720-4 (no plow)

1 1/2 x 3 1/4

N720-6P (with 1 1/4 plow)

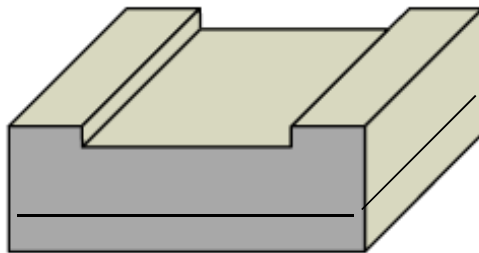

N379B (1 1/4 Plow)

1 x 2 1/8

N379S (1 1/4 Plow)

3/4 x 2 1/8

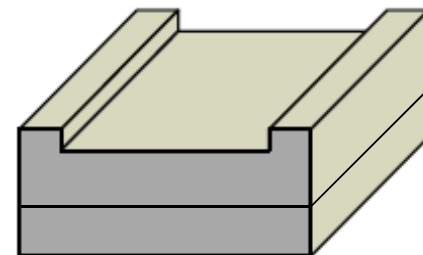

N720B (1 1/4 Plow)

1 1/4 x 1 1/2

N720S (1 1/4 Plow)

3/4 x 1 1/2

720 SERIES

N728
3/4 x 7 1/4
Tall Base

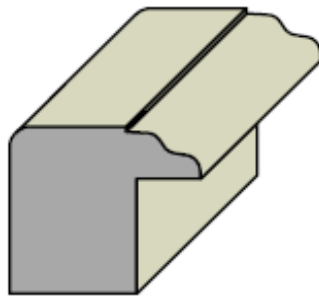
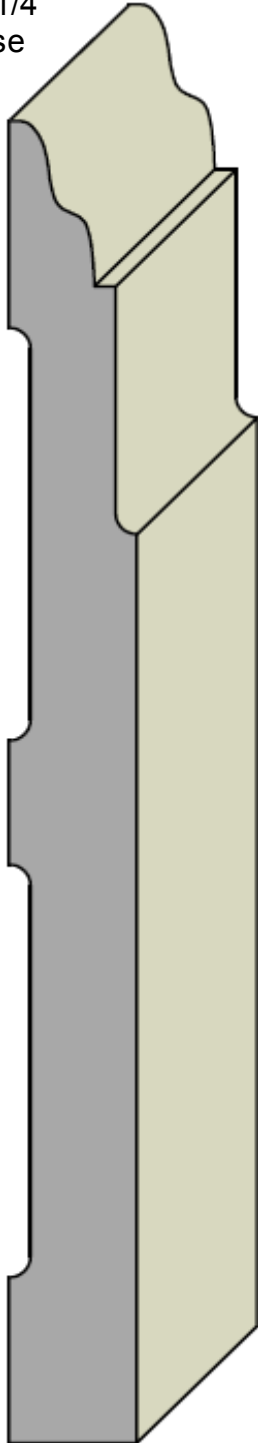

N725
1 x 1 1/4 x 5/8
Backband

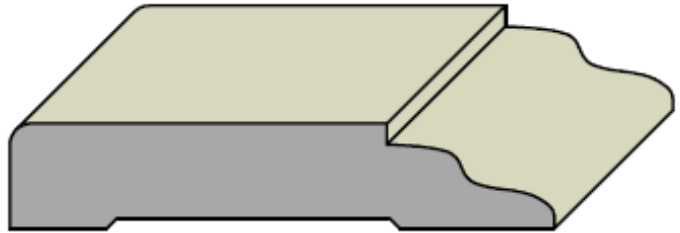

N722C
5/8 x 3 1/4
Casing

N722B
1/2 x 5 1/4
Base

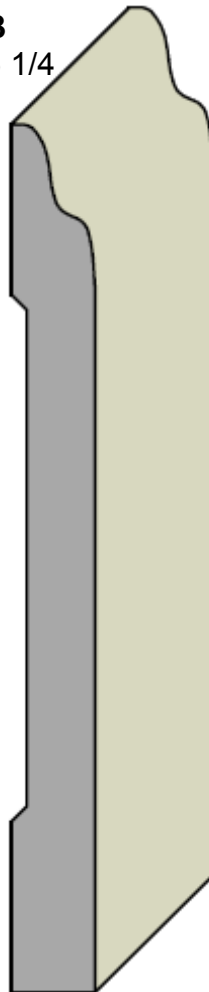

LOON COUNTRY

LC01-525-1 (1 EE)
LC01-525-2 (2 EE)
3/4 x 5 1/4
Header



LC01-425-1 (1 EE)
LC01-425-2 (2 EE)
3/4 x 4 1/4
Header



LC05-125
1/2 x 1 1/4
Bead

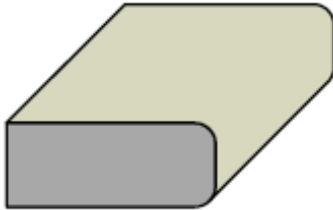

LC02-325
5/8 x 3 1/4
Casing



LC06-125
3/4 x 1 1/4
Stool

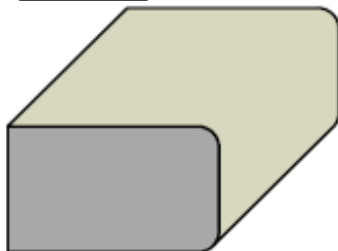

LC01-325-1 (1 EE)
LC01-325-2 (2 EE)
3/4 x 3 1/4
Apron



LC9125-2
7/8 x 1 1/4 x 5/8
Backband

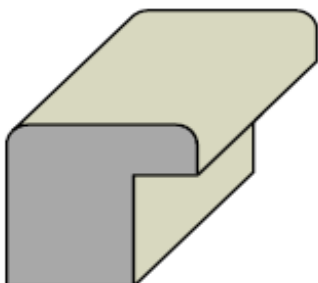

LC03-525
1/2 x 5 1/4
Base

LC03-425
1/2 x 4 1/4
Base

